



# Suprema Product Overview

2021

**Suprema**  
SECURITY & BIOMETRICS

# Contents

BioStar 2  
Access Control

Biometrics

Mobile

RFID  
Reader

Controller

Contactless  
Solution

System  
Topology

Development  
Tools

Product  
Data Sheet









# Proven Leader in Access Control, Time & Attendance and Biometric Solutions





Founded in 2000, Suprema Inc. has become a leading global provider of security and biometrics. By combining world-renowned biometric algorithms with superior engineering, Suprema has introduced a number of technology innovations to the security industry over the last two decades.

Suprema's extensive portfolio includes biometric access control systems, time & attendance solutions, fingerprint live scanners, mobile authentication solutions and embedded fingerprint modules.

The company has established itself as a global premium brand in the physical security industry and has worldwide sales network in over 140 countries. Suprema has no. 1 market share in biometric access control in Europe, Middle East and Africa region and has been named the world's top 50 security manufacturers for ten consecutive years.



Year Established

**2000**



Security Manufacturer

**Top 50**

(A&S Magazine, 2011-2020,  
10 years in a row)



EMEA Market Share

**No.1**

in Biometric Access Control  
(IHS Markit)



Number of people using  
Suprema technologies

**1 Billion +**



Systems  
in Operation

**1.5 Million +**

(worldwide installations)



Global Sales  
Network in

**140 Countries**



National Identification  
Projects in

**23 Countries**



Industry Patents and  
Intellectual Properties

**100+**



Excellent Financial  
Stability

**A+**

(Korea Investors Service)









Monitor 1

### Dashboard

Summary

August 2021 - July 2022

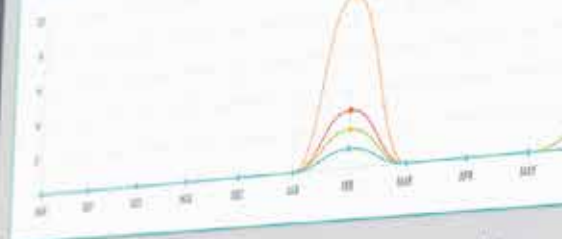

### Usage



### Notice

Notice

### Missed Alerts

ID	Name	Link
0000000102	Notification 1 (10/10/2021) (10/10/2021)	
0000000103	Notification 2 (10/10/2021) (10/10/2021)	





# BioStar 2 Access Control

BioStar 2 is a web-based, open, and integrated security platform that provides comprehensive functionality for access control, time & attendance, visitor management, and video logs. It supports web API to integrate BioStar 2 with 3rd party software.

In addition, users can control the BioStar 2 platform remotely with the mobile app for BioStar 2 and manage Suprema Mobile Access, a mobile credential system that uses smartphones as access keys.



# BioStar 2 TA

Build a more flexible time & attendance system with BioStar 2 TA module. It lets you set an unlimited number of schedules and specify the number of users for each schedule. BioStar 2 time & attendance module is ideal for an enterprise level system or create a variety of time & attendance rules.



Various Shift Settings



Flexible Work Management



Easy Shift Type Setting



Timesheet Calendar View

# BioStar 2 AC

With the purchase of BioStar 2 AC license, you can use advanced access control features like elevator control, advanced anti-passback zone control, fire alarm zone, scheduled lock/unlock zone, intrusion alarm zone, server matching, and video log features.



Customized System Architecture



Elevator Control



Improved Zone Management



Server Matching



Video Logs



Visitor Management





# BioStar 2, certified for data protection

Suprema BioStar 2 platform and access control devices are certified by ISO for data protection measures and are GDPR and CCPA compliant, meeting all of 26 data protection management standards, 114 data protection control and 18 personal information management requirements.

All personal information stored in Suprema products, including biometric data, are encrypted using AES algorithm and the encryption keys are safely managed in cryptochips(SecureElement), with access routes securely blocked.

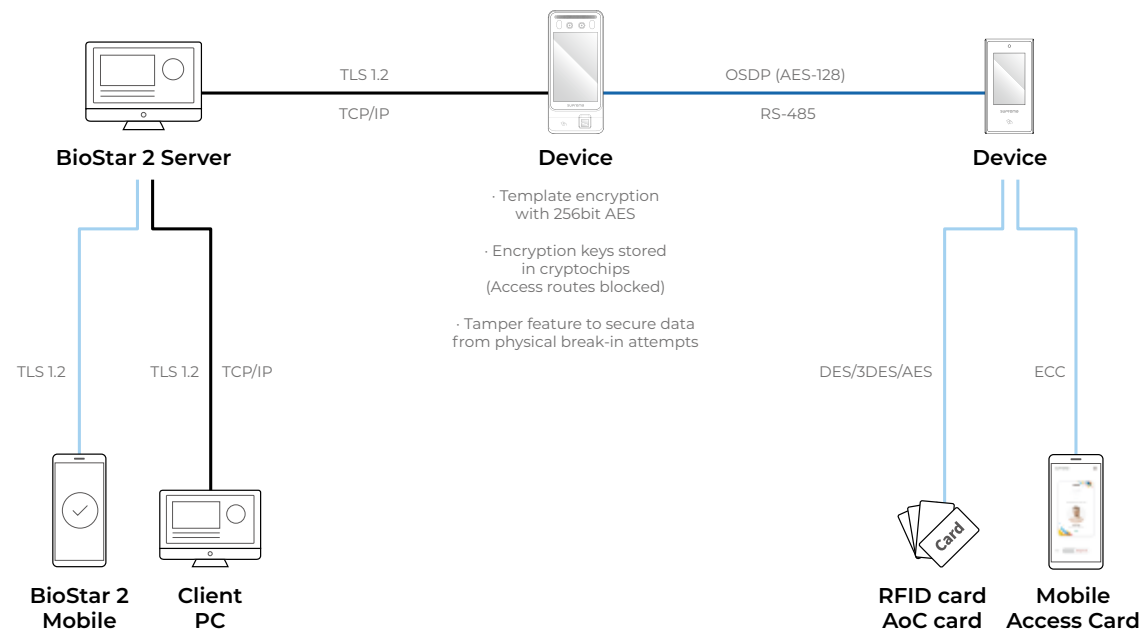



# | Biometrics

Leading provider of biometric solutions since 2000, Suprema has continuously innovated fingerprint and face recognition technology as well as deep learning artificial intelligence that is core to biometric solutions.



# Artificial Intelligence

Artificial intelligence is core to biometric recognition technology. Leading provider of biometrics solutions for twenty years, Suprema has naturally advanced its computer vision with machine learning technology as well. Facing and solving real-world problems over the two decades, Suprema has accumulated technological know-how that late comers into the field have not acquired. Because Suprema designs, develops and manufactures the entire product—from algorithm and software to hardware as well—the company possesses technological capability that can optimize and expand upon AI for platforms ranging from the cloud to embedded systems.



# Face Recognition



Lately, face recognition products based on visual deep learning technology are pouring into the market. Suprema has developed a unique “Fusion Matching” technology that combines its ten years of experience in IR face recognition with visual face recognition methods. For Fusion Matching, IR and visual cameras each capture face photos, generating two types of templates. Face recognition terminal performs the matching of both IR and visual templates and optimizes the two matching scores, balancing them alongside environmental factors like intensity of illumination. Suprema employs its unique algorithm to fuse the two two scores, yielding a highly accurate recognition performance. FaceStation F2, Suprema’s latest face recognition terminal that utilizes Fusion Matching, boasts false acceptance rate of 1 in 10 billion, matching up to 10,000 people per second.

Fusion matching technology provides enhanced anti-spoofing performance as well. Using both the IR and visual face recognition to check captured images for intensity of illumination and other environmental values, Fusion matching detects various types of fake facial representations.

# Fingerprint Recognition

Suprema’s fingerprint recognition technology is the world’s fastest, most accurate and stable with the false acceptance rate of only rate of 1 in 10 million, matching up to 150,000 people per second. Suprema employs a unique sensor imaging technology that reduces image distortion and uniformly corrects the contrast to enhance authentication performance. Suprema technology identifies fake fingerprints forged with various materials like paper, film, rubber, clay, silicone, and adhesives by comparing irregular fingerprint patterns as well as fingerprint images obtained via infrared and white light. Suprema fingerprint recognition received international certifications (NIST MINEX, FBI, IQS, STQC, FVC) and is suitable for governmental and official authentication purposes.



# Mobile

Along with biometrics, using smartphones as credentials is a growing trend in the access control industry. Suprema lets users replace RF cards and fobs with Mobile Access cards and QR codes issued and managed either on Suprema system or 3rd party solutions.







# Suprema Mobile Access

Suprema Mobile Access significantly improves user convenience by letting people use smartphones as access cards. Mobile access cards can be issued on either BioStar 2 or Suprema Airfob Portal and users can receive them via email. Suprema Mobile Access can easily be integrated with 3rd party systems.



- 

Fast and easy contactless solution
- 

Support both NFC & BLE (Bluetooth 4.2 or above)
- 

Remote management via web portal
- 

Background mode (BLE, Standby mode)
- 

Compatible with Android (9.0 or above) & iOS (7.0 or above)

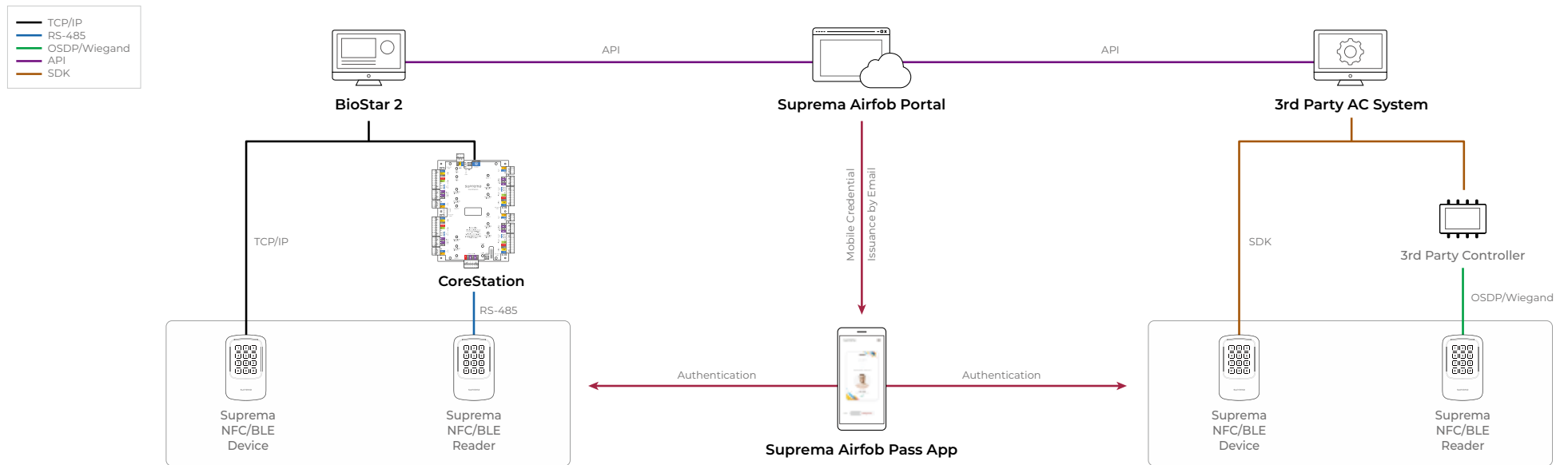

# Suprema Airfob Patch

Suprema Airfob Patch can be attached to existing RF card readers to translate Mobile Access Card's Bluetooth or NFC signals to RF card signal, making them compatible with credentials stored in mobile devices. Airfob Patch works without battery, harvesting energy from RF signals transmitted from the card reader.



# QR Code

Suprema offers the option of using QR codes as credential. Suprema's versatile intelligent terminal X-Station 2 can read QR codes composed of up to 32 ASCII codes. QR codes can be issued on BioStar 2 or 3rd party systems.

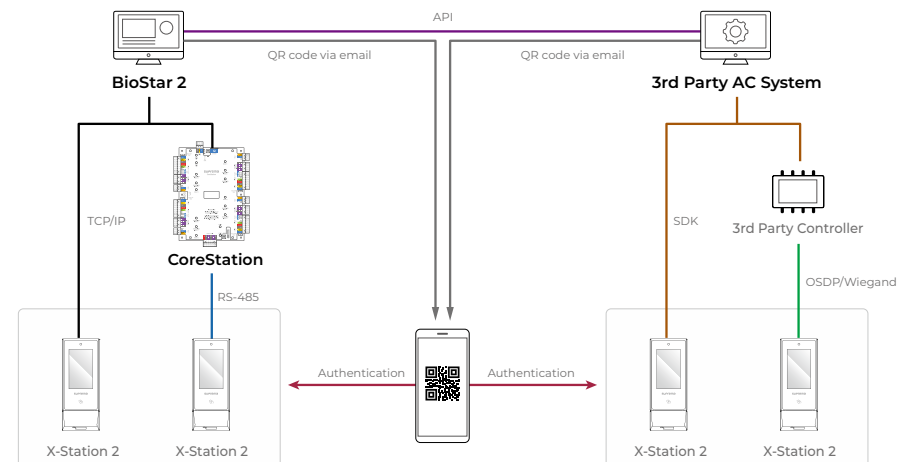



# RFID Reader

Suprema offers card readers that support dual-frequency RFID technology, compatible with a wide range of card types including MIFARE, DESFire, FeliCa and EM. Suprema card readers can also read mobile credentials using both NFC and BLE communication. Recently released Suprema X-Station 2 is equipped with color LCD touchscreen and QR code recognition and can be used to manage time and attendance as well as visitor passage and access control at unmanned facilities.



## X-Station 2 | Versatile Intelligent Terminal

- Compatible with most RFID cards, Mobile Access cards, QR codes
- Enhanced security with Secure Boot and OSDP(Open Supervised Device Protocol)
- Built-in Camera for image logs



## XPass 2 | Outdoor Compact RFID Device

- Compatible with most RFID cards and dual-frequency
- Mobile Access cards
- IP67 and IK08 Vandal-proof structure



## XPass D2 | Outdoor Compact RFID Reader

- Compatible with most RFID cards and dual-frequency
- Mobile Access cards\*
- IP67 and IK08 Vandal-proof structure
- SIA OSDP verified

\* Suprema Mobile Access is supported on XPass D2 - V02A H/W versions only.

# Controller

Suprema controller provides the advantages of a biometric-enabled security over a centralized access control system.



## CoreStation | Intelligent Biometric Controller

Designed to accommodate enterprise-level systems, Suprema CoreStation stores up to 500,000 users with an incredible fingerprint matching speed of up to 400,000 match per second. Its multi-port interface also supports nonbiometric access control system such as RFID card readers, door locks, alarms sensors and RTE. With its high-performance, biometric readiness and Ethernet communication, CoreStation lets users access the full features of the BioStar 2 platform. Suprema CoreStation can be used in conjunction with door modules and output extension modules to control up to 132 access points. Suprema modules provides secure connection with encrypted communication.

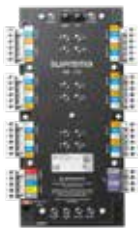

### Output Module (OM-120)

- Up to 12 output relays
- Elevator control with BioStar 2
- Anti-passback, fire alarm feature



### Secure Module (SIO2)

- Secure door control
- Encrypted communication
- Compact form factor



### Door Module (DM-20)

- Up to 4 doors
- Encrypted communication
- Two Wiegand interfaces





# Contactless Solution

Suprema contactless temperature detection solution is a one-stop access control and safety solution that provides both facial recognition and skin temperature detection. Thermal camera measures skin temperature without physical contact while face recognition cameras recognizes registered users to grant or deny access. The solution can recognize people who are wearing masks, and give alerts or block access of those not wearing masks.

## Enhanced Security and Safety

- Detects skin temperature and displays on GUI
- Raises alerts or denies access when higher than threshold temperature is detected



## Accurate Temperature Measurement

- Increased accuracy of the temperature measurement by pinpointing upper area of the face using Suprema's face recognition algorithm



## Contactless and Remote features

- Remote user enrollment via photo uploads
- Detection of users not wearing masks
- Face recognition of users wearing masks



Disclaimer: Suprema products are not used to diagnose any medical conditions. Suprema thermal cameras can identify individuals with skin temperature higher than a preset figure but should not be solely or primarily relied upon to diagnose or exclude a diagnosis of COVID-19, or any other disease. Only a licensed medical professional can determine if a person with elevated skin temperature is symptomatic of a specific medical condition.

# System Topology

Depending on customer needs, Suprema access control devices can be set up in a distributed or centralized system.







## Distributed System

In distributed systems, IP terminals and readers perform the roles of a controller and reader simultaneously, letting you undertake functions such as user management, access control management, and biometric recognition on a single terminal. Suprema's IP terminals and readers improve system reliability with easy system configuration and distributed management. It also provides the benefits of simple wiring, low installation and maintenance costs.

- 

Biometrics-Based System
- 

Easy Installation
- 

Outstanding Scalability
- 

Various Biometrics Devices available
- 

Low Installation and Maintenance Costs

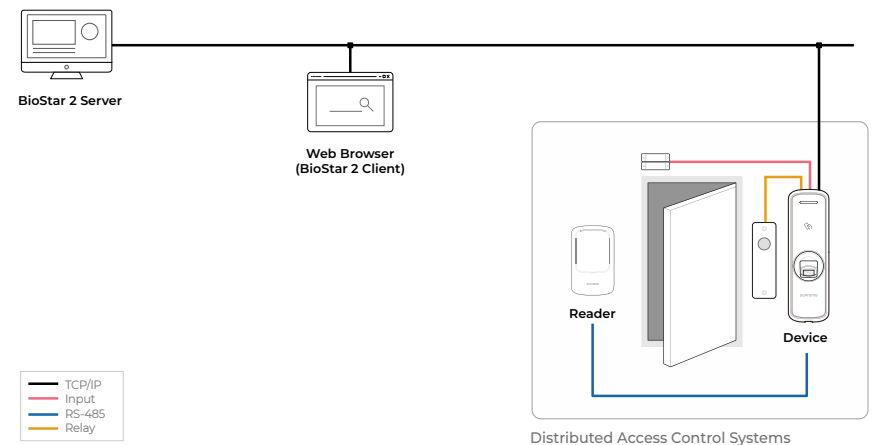

# Centralized System

With Suprema's CoreStation and readers, you can build a centralized system, which is a system based on access control units (ACU). Suprema's centralized system provides enhanced security and excellent system scalability. The centralized system also enables you to upgrade your existing systems at lower installation cost. Integrated with BioStar 2, this system safely stores all information about each user including the user's name, ID, PIN, access rights and fingerprint data on a single device.

- 

Biometrics-Based System
- 

Enterprise-Class Performance
- 

Outstanding Scalability
- 

Improved Security
- 

Easy Installation

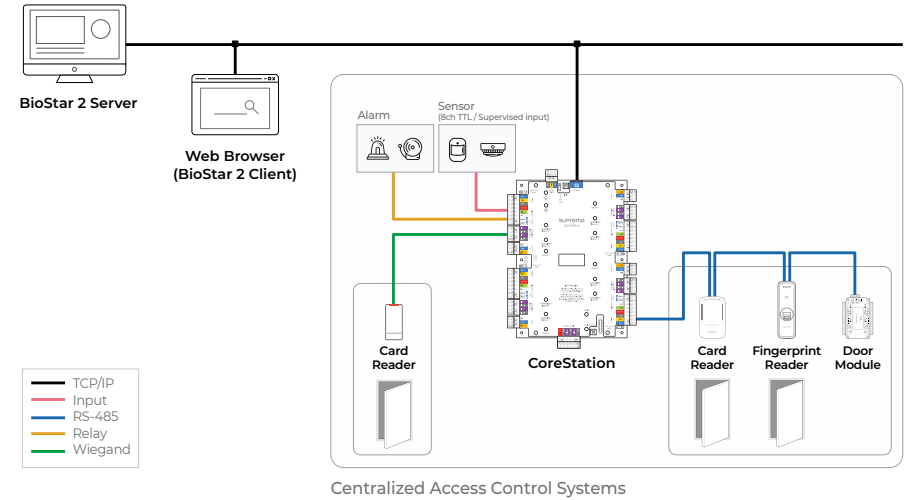



## CoreStation 4 Door Access Control Kit | Complete Access Control Solution

CoreStation 4 Door Access Control Kit contains all components necessary to secure 4 doors. It includes BioStar 2 Access Control Software, CoreStation door controller, 4x access readers of your choice (RFID or Biometrics), and 50 free credits for Suprema Mobile Access. Easily set up a centralized access control system, choosing the credentials of your choice with options: Card, PIN, biometrics, and mobile access cards.



All-In-One Kit



Cost-Effective



Easy to Install







| Development  
Tools

## Suprema G-SDK

Suprema G-SDK is a highly-scalable development kit that enables device management for multi-site, multi-tenant customers. It is mobile and cloud-friendly, allowing you to easily add and manage devices via Device Gateways when a new site is added. Based on gRPC, Suprema G-SDK supports many programming languages including Java, C#, Python, Node.js, Go, and C++.

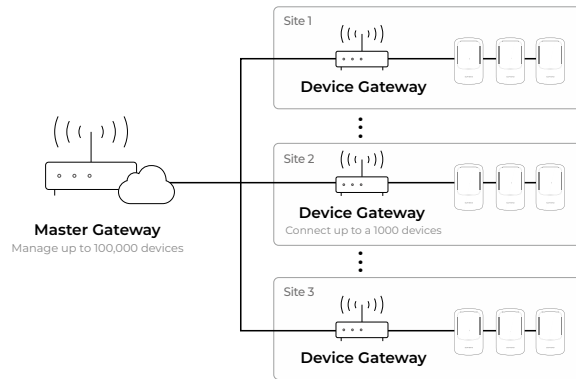

## Suprema Versatile Platform (SVP) Android SDK

The Suprema Versatile Platform(SVP) Android SDK allows you to create customized apps to run on Suprema's time & attendance and workforce management terminals, NOVUS and OMNIS. The SDK is made up of APIs that let you develop Android applications for utilizing NOVUS and OMNIS' full functionality.

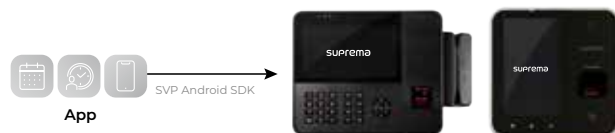

## BioStar 2 Device SDK

BioStar 2 Device SDK is a development tool that enables you to control the core features of Suprema's terminal through 3rd party software.

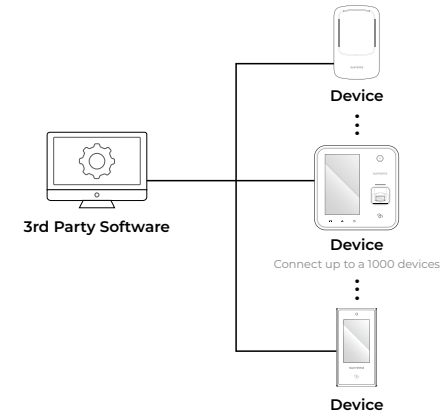

## BioStar 2 API

BioStar 2 API is a Web API that enables integration between BioStar 2 and 3rd party softwares. BioStar 2 API are standardized and allows communication using REST and JSON, making integration and app development easy.













# Product Data sheet

Product						
Product Name		FaceStation F2	FaceStation 2	FaceLite	BioStation A2	BioStation 2
General	Biometrics	FSF2-DB, AB: Face / FSF2-ODB: Face, Fingerprint	Face	Face	Fingerprint	Fingerprint
	LFD (Live Finger Detection)	FSF2-DB, AB: - / FSF2-ODB: Supported (SW-based)	-	-	Supported	-
	Protection Class	IP65	-	-	-	IP65
	RF Options	FSF2-DB: 125kHz EM & 13.56MHz MIFARE, MIFARE Plus, DESFire EV1/EV2 <sup>2</sup> , FeliCa	FL-DB 125kHz EM & 13.56MHz MIFARE, MIFARE Plus, DESFire EV1/EV2 <sup>2</sup> , FeliCa	FL-DB: 125kHz EM & 13.56MHz MIFARE, MIFARE Plus, DESFire EV1/EV2 <sup>2</sup> , FeliCa	BSA2-OEPW: 125kHz EM	BS2-OEPW: 125kHz EM
		FSF2-AB: 125kHz EM, HID Prox & 13.56MHz MIFARE, MIFARE Plus, DESFire EV1/EV2 <sup>2</sup> , FeliCa, iCLASS SE/SR/Seos	FS2-AWB: 125kHz EM, MIFARE Plus, HID Prox & 13.56MHz MIFARE, DESFire EV1/EV2 <sup>2</sup> , FeliCa, iCLASS SE/SR/Seos		BSA2-OHPW: 125kHz HID Prox	BS2-OHPW: 125kHz HID Prox
		FSF2-ODB: 125kHz EM & 13.56MHz MIFARE, MIFARE Plus, DESFire EV1/EV2 <sup>2</sup> , FeliCa			BSA2-OIPW: 13.56MHz iCLASS SE/SR/Seos	BS2-OIPW: 13.56MHz iCLASS SE/SR/Seos
Mobile	NFC, BLE	FS2-D: NFC / FS2-AWB: NFC, BLE	NFC, BLE	BSA2-OMPW: NFC / BSA2-OIPW: NFC BSA2-OEPW, BSA2-OHPW: Not Supported	BS2-OMPW: NFC / BS2-OIPW: NFC BS2-OEPW, BS2-OHPW: Not Supported	
Capacity	Max. User <sup>(1)</sup>	100,000	30,000	Face: 30,000	500,000	500,000
	Max. Credential (1:N)	Face: 50,000 Fingerprint: 100,000	Face: 4,000	Face: 4,000	Fingerprint: 100,000	Fingerprint: 200,000
	Max. Credential (1:1)	Face: 100,000 Fingerprint: 100,000 PIN: 100,000 Card: 100,000	Face: 30,000 Card: 30,000	Face: 30,000 Card: 30,000	Fingerprint: 500,000 Card: 500,000 PIN: 500,000	Fingerprint: 500,000 PIN: 500,000 Card: 500,000
	Max. Text Logs	5,000,000	5,000,000	5,000,000	5,000,000	3,000,000
	Max. Image Logs	50,000	50,000	-	50,000	-
Interfaces	Wi-Fi	-	FS2-D: Not Supported / FS2-AWB: Supported	-	Supported (Built-in)	Supported (Built-in)
	TCP/IP	Supported	Supported	Supported	Supported	Supported
	RS-485	1ch Host or Slave (Selectable)	1ch Host or 1ch Slave	1ch Host or 1ch Slave	1ch Host or Slave	1ch Host or Slave
	Wiegand	1ch Input or Output (Selectable)	1ch In and 1ch Out	1ch In and 1ch Out	1ch In and 1ch Out	1ch In and 1ch Out
	I/O	2ch Inputs	2 Inputs	2 Inputs	2 Inputs	2 Inputs or 2 Outputs
	Relay	1 Relay	1 Relay	1 Relay	2 Relays	1 Relay
	USB	USB 2.0 (Host)	USB 2.0 (Host)	USB 2.0 (Host)	USB 2.0 (Host)	USB 2.0 (Host)
Hardware	CPU	1.8 GHz Dual Core + 1.4 GHz Quad Core	1.4 GHz Quad Core	1.2 GHz Quad Core	1 GHz Quad Core	1.0 GHz
	Memory	16 GB Flash + 2 GB RAM	8 GB Flash + 1 GB RAM	8 GB Flash + 1 GB RAM	8 GB Flash + 1 GB RAM	8 GB Flash + 256 MB RAM
	Crypto Chip	Supported	Supported	Supported	Supported	Supported
	Audio	16 bit	24 bit/Voice DSP (echo cancellation)	24 bit/Voice DSP (echo cancellation)	24 bit/Voice DSP (echo cancellation)	16-bit Hi-Fi
	Operating Temperature	-20°C ~ 50°C (-4°F ~ 122°F)	-20°C ~ 50°C (-4°F ~ 122°F)	-20°C ~ 50°C (-4°F ~ 122°F)	-20°C ~ 50°C (-4°F ~ 122°F)	-20°C ~ 50°C (-4°F ~ 122°F)
	Tamper	Supported	Supported	Supported	Supported	Supported
	Power	Voltage: DC 12V ~ DC 24V / Current: Max. 2.5 A	DC 24V	DC 24V	DC 12V	DC 12V
	PoE	-	-	-	Supported	Supported
	Dimensions (W x H x D mm)	FSF2-DB, AB: 119.8 x 223 x 23.5 FSF2-ODB: 119.8 x 268.4 x 49.7	141 x 164 x 125	80 x 170 x 76	155 x 155 x 40	142 x 144 x 45
	Certifications	CE, FCC, KC, RoHS, REACH, WEEE	CE, FCC, KC, RoHS, REACH, WEEE, BT SIG	CE, FCC, KC, RoHS, REACH, WEEE, BT SIG	CE, FCC, KC, RoHS, REACH, WEEE	CE, FCC, KC, RoHS, REACH, WEEE

<sup>(1)</sup> The number of users registered without any credential data. <sup>(2)</sup> DESFire EV2 cards are supported by having backward compatibility of DESFire EV1 cards. CSN and smart card functions are compatible with Suprema devices.

						
BioStation L2	BioLite N2	BioEntry W2 <sup>(3)</sup>	BioEntry P2	X-Station 2	XPass 2	XPass S2
Fingerprint	Fingerprint	Fingerprint	Fingerprint	<b>XS2-ODPB, XS2-OAPB:</b> Fingerprint <sup>(4)</sup>	-	-
Supported	-	Supported	-	-	-	-
-	IP65, IP67	IP67, IK09	-	IP65	IP65, IP67, IK08	IP65
<b>BSL2-OE:</b> 125kHz EM	<b>BLN2-ODB:</b> 125kHz EM & 13.56MHz MIFARE, MIFARE Plus, DESFire EV1/EV2 <sup>2)</sup> , FeliCa <b>BLN2-OAB:</b> 125kHz EM, HID Prox & 13.56MHz MIFARE, MIFARE Plus, DESFire EV1/EV2 <sup>2)</sup> , FeliCa, iCLASS SE/SR/Seos	<b>BEW2-ODPB:</b> 125kHz EM & 13.56MHz MIFARE, MIFARE Plus, DESFire EV1/EV2 <sup>2)</sup> , FeliCa <b>BEW2-OHPB:</b> 125kHz EM, HID Prox & 13.56MHz MIFARE, MIFARE Plus, DESFire EV1/EV2 <sup>2)</sup> , FeliCa	<b>BEP2-OD:</b> 125kHz EM & 13.56MHz MIFARE, MIFARE Plus, DESFire EV1/EV2 <sup>2)</sup> , FeliCa <b>BEP2-OA:</b> MIFARE Plus, DESFire EV1/EV2 <sup>2)</sup> , 125kHz EM, HID Prox & 13.56MHz MIFARE, FeliCa, iCLASS SE/SR/Seos	<b>XS2-ODPB, XS2-OAPB, XS2-DPB, XS2-QDPB:</b> 125 kHz EM & 13.65 MHz MIFARE, MIFARE Plus, DESFire EV1/EV2 <sup>2)</sup> (CSN), FeliCa <b>XS2-APB, XS2-QAPB:</b> 125 kHz EM HID Prox & 13.65 MHz MIFARE, MIFARE Plus, DESFire EV1/EV2 <sup>2)</sup> , FeliCa, iCLASS SE/SR/Seos	125kHz EM & 13.56MHz MIFARE, MIFARE Plus, DESFire EV1/EV2 <sup>2)</sup> , FeliCa	13.56MHz MIFARE, MIFARE Plus, DESFire EV1/EV2 <sup>2)</sup> (CSN), FeliCa
<b>BSL2-OM:</b> 13.56MHz MIFARE, MIFARE Plus, DESFire EV1/EV2 <sup>2)</sup> , FeliCa	<b>BLN2-PAB:</b> 125kHz EM, HID Prox & 13.56MHz MIFARE, MIFARE Plus, DESFire EV1/EV2 <sup>2)</sup> , FeliCa, iCLASS SE/SR, iCLASS Seos	<b>BEW2-OAPB:</b> 125kHz EM, MIFARE Plus, HID Prox & 13.56MHz MIFARE, DESFire EV1/EV2 <sup>2)</sup> , FeliCa, iCLASS SE/SR/Seos				
<b>BSL2-OM:</b> NFC <b>BSL2-OE:</b> Not Supported	NFC, BLE	NFC, BLE	NFC	NFC, BLE	NFC, BLE	Not Supported
500,000	10,000	500,000	10,000	500,000	200,000	50,000
Fingerprint: 100,000	Fingerprint: 10,000	Fingerprint: 100,000	Fingerprint: 10,000	Fingerprint: 100,000 ( <b>XS2-ODPB, XS2-OAPB</b> only)	-	-
Fingerprint: 500,000 Card: 500,000	Fingerprint: 10,000 Card: 10,000	Fingerprint: 500,000 Card: 500,000	Fingerprint: 10,000 Card: 10,000	Fingerprint: 500,000 ( <b>XS2-ODPB, XS2-OAPB</b> only) Card: 500,000 PIN: 500,000	Card: 200,000 PIN: 200,000	Card: 50,000
1,000,000	1,000,000	1,000,000	1,000,000	5,000,000	1,000,000	100,000
-	-	-	-	50,000	-	-
-	-	-	-	-	-	-
Supported	Supported	Supported	Supported	Supported	Supported	Supported
1ch Host or Slave	1ch Host or Slave	1ch Host or Slave	1ch Host or Slave	1ch Host or Slave	1ch Host or Slave	1ch Host or Slave
1ch In or Out	1ch In or Out	1ch In or Out	1ch In or Out	1ch In or Out	1ch In or Out	1ch In or Out
2 Inputs	2 Inputs	2 Inputs	2 Inputs	2 Inputs	2 Inputs	2 Inputs
1 Relay	1 Relay	1 Relay	1 Relay	1 Relay	1 Relay	1 Relay
-	-	-	-	USB 2.0 (Host)	-	-
1.2 GHz Quad Core	1.2 GHz	1.2 GHz Quad Core	1.0 GHz	1.5 GHz Quad Core	1.0 GHz	533 MHz DSP
2 GB Flash + 256 MB RAM	4 GB Flash + 64MB RAM	2 GB Flash + 256 MB RAM	8 GB Flash + 64 MB RAM	16 GB Flash + 1 GB RAM	4 GB Flash + 64 MB RAM	16 MB Flash + 16 MB RAM
Supported	Supported	Supported	Supported	Supported	Supported	Supported
16-bit Hi-Fi	16-bit Hi-Fi	Multi-tone Buzzer	Multi-tone Buzzer	24bit	Multi-tone Buzzer	Multi-tone Buzzer
-20°C ~ 50°C (-4°F ~ 122°F)	<b>BLN2-ODB, BLN2-OAB:</b> -20°C ~ 50°C (-4°F ~ 122°F) <b>BLN2-PAB:</b> -10°C ~ 50°C (14°F ~ 122°F)	-20°C ~ 50°C (-4°F ~ 122°F)	-20°C ~ 50°C (-4°F ~ 122°F)	-20°C ~ 50°C (-4°F ~ 122°F)	-35°C ~ 65°C (-31°F ~ 149°F)	-35°C ~ 65°C (-31°F ~ 149°F)
Supported	Supported	Supported	Supported	Supported	Supported	Supported
DC 12V	DC 12V	DC 12V	DC 12V	DC 12V (MAX. 0.8A) or DC 24V (MAX. 0.45A)	DC 12V / DC 24V	DC 12V
-	-	Supported	-	Supported	Supported	-
71 x 201 x 44	58 x 190 x 44	50 x 172 x 43.5	50 x 164 x 37.5	<b>XS2-ODPB/XS2-OAPB:</b> 82 x 208.5 x 25.9 <b>XS2-DPB/XS2-APB:</b> 82 x 159 x 25.9 <b>XS2-QDPB/XS2-QAPB:</b> 82 x 203 x 33.9	<b>XP2-MDPB:</b> 48 x 145 x 27 <b>XP2-GDPB/GKDPB:</b> 80 x 130 x 25	80 x 120 x 11.4
CE, FCC, KC, RoHS, REACH, WEEE	CE, FCC, KC, RoHS, REACH, WEEE	CE, FCC, KC, RoHS, REACH, WEEE, UL 294	CE, FCC, KC, RoHS, REACH, WEEE	CE, FCC, KC, RoHS, REACH, WEEE	CE, FCC, KC, RoHS, REACH, WEEE, SIG	CE, FCC, KC, RoHS, REACH, WEEE

<sup>(3)</sup> Some models(BEW2-ODP, BEW2-OAP, BEW2-OHP) do not support BLE. <sup>(4)</sup> Scheduled to be released in the second half of 2021.





Product		
Product Name		<b>CoreStation (CS40)</b>
Capacity	Max. User	500,000
	Max. Credential (1:N)	Face: 100,000 Fingerprint: 100,000
	Max. Credential (1:1)	Face: 500,000 Fingerprint: 500,000 Card 500,000 PIN: 500,000
	Max. Text Logs	5,000,000
Interfaces	TCP/IP	Supported
	RS-485	5ch
	RS-485 Communication Protocol	OSDP V2 Compliant
	Wiegand	4ch
	Relay	4 Relay
	TTL Input	8ch (Supervised Input Selectable)
	TTL Output	8ch
AUX Input	2ch (AC Power Fail, Tamper)	
Connectivity	Max. Slave Devices (RS-485)	Max. 64 devices (Max. 31 devices per port)
	Max. Wiegand Devices	Max. 132 devices (with DM-20)
Hardware	CPU	1.4 GHz Octa Core
	Memory	8 GB Flash + 1 GB RAM
	LED	Multi-color
	Operating Temperature	0°C ~ 50°C (32°F ~ 122°F)
	Tamper	Optional (ENCR-10)
	Power	DC 12V
	Dimensions (W x H x D mm)	150 x 214 x 21
Certifications	CE, FCC, KC, RoHS, REACH, WEEE, UL294	

Product			
Product Name		<b>BioEntry R2</b>	<b>XPass D2</b>
General	Biometrics	Fingerprint	-
	Protection Class	-	IP65, IP67, IK08
	RF Options	<b>BER2-OD:</b> 125kHz EM & 13.56MHz MIFARE, MIFARE Plus, DESFire EV1/EV2 <sup>(5)</sup> , FeliCa	<b>XP2-MDB, XP2-GDB, XP2-GKDB:</b> 125kHz EM & 13.56MHz MIFARE, MIFARE Plus, DESFire EV1/EV2 <sup>(5)</sup> , FeliCa, NFC & 2.4GHz BLE
	Mobile	<b>BER2-OD:</b> NFC	<b>XP2-MDB, XP2-GDB, XP2-GKDB:</b> NFC, BLE
Interfaces	RS-485	1ch Slave	1ch Slave
	Wiegand	-	1ch Out
Hardware	CPU	1.0 GHz Quad Core	80 MHz
	Memory	32 MB Flash + 32 MB RAM	512 KB Flash + 160 KB RAM
	Audio	Multi-tone Buzzer	Multi-tone Buzzer
	Operating Temperature	-20°C ~ 50°C (-4°F ~ 122°F)	-35°C ~ 65°C (-31°F ~ 149°F)
	Tamper	Supported	Supported
	Power	DC 12V	DC 12V
	Dimensions (W x H x D mm)	50 x 164 x 37.5	<b>XP2-MDB:</b> 48 x 144.7 x 27 <b>XP2-GDB/GKDB:</b> 80 x 130 x 25
Certifications	CE, FCC, KC, RoHS, REACH, WEEE	CE, FCC, KC, RoHS, REACH, WEEE, SIG	

Product				
Product Name		<b>Output Module (OM-120)</b>	<b>Door Module (DM-20)</b>	<b>Secure Module (Secure I/O 2)</b>
Interfaces	RS-485	1ch	1ch	1ch
	Wiegand	-	2ch	-
	Relay	12 Relays	4 Relays	1 Relay
	Input	-	TTL Input: 4ch / Supervised Input: 4ch	2ch
	Output	-	6ch	-
	AUX Input	2ch Dry Contact Input	-	-
Hardware	CPU	Cortex M3 72MHz	Cortex M 32MHz	Cortex M 32MHz
	Memory	128 KB Flash + 20 KB SRAM	128 KB Flash + 20 KB SRAM	128 KB Flash + 20 KB SRAM
	LED	Multi-color	Multi-color	Multi-color
	Operating Temperature	-20°C ~ 60°C (-4°F ~ 140°F)	-20°C ~ 60°C (-4°F ~ 140°F)	-20°C ~ 50°C (-4°F ~ 122°F)
	Power	DC 12V	DC 12V	DC 12V
	Dimensions (W x H x D mm)	90 x 190 x 21	130 x 90.5 x 35.8	36 x 65 x 18
	Certifications	CE, FCC, KC, RoHS, REACH, WEEE	CE, FCC, KC, RoHS, REACH, WEEE	CE, FCC, KC, RoHS

<sup>(5)</sup> DESFire EV2 cards are supported by having backward compatibility of DESFire EV1 cards. CSN and smart card functions are compatible with Suprema devices.



**Suprema Inc.**

17F Parkview Tower, 248, Jeongjail-ro, Bundang-gu, Seongnam-si, Gyeonggi-do, 13554, Republic of Korea

T +82 31 783 4502    [www.supremainc.com](http://www.supremainc.com)



For more information visit our website below by scanning the QR code.  
<https://www.supremainc.com/en/about/contact-us.asp>

©2021 Suprema Inc. Suprema and identifying product names and numbers herein are registered trademarks of Suprema, Inc. All non-Suprema brands and product names are trademarks or registered trademarks of their respective companies. Product appearance, build status and/or specifications are subject to change without notice. [SUPREMA-AMB-LB-EN-REV29]

